

Resistive HMI VC4000 Series

Module: VC4043E

Overview

- Metal enclosure, better heat dissipation and stronger anti-interference ability.
- The main board is treated with a special coating (three anti-paint) to adapt to harsh Environment.
- High resolution, high brightness, LED backlight, more energy saving and environmental Protection.
- Streamlined two-way communication ports. The USB host port supports U disk to storage and download data.
- New configuration software, rich library, powerful features.
- 2-way serial port, with Ethernet, more powerful expansion function.



Appearance



Specifications

Hardware Parameter	Display	4.3" 16:9 TFT LCD
	Resolution(WxH)	480×272
	Colors	24-bit
	Brightness	300 cd/m ²
	Backlight	LED
	LCD Life	50000 hours
	Touch Panel	4 wires resistive touch screen(Surface hardness 4H)
	CPU	600MHz ARM Cortex-A8
	Memory	128M Flash + 128M DDR3
	RTC	Built in
	Ethernet	10/100M auto adaptation
	USB Port	USB Slave 2.0 Port*1,USB Host 2.0 Port*1
	Download Project	USB Slave Port/U-disk/Ethernet
	COM Port	COM1:RS232/RS485/RS422, COM3:RS232
	LCD viewing angle (T/B/L/R)	50'/70'/70'/70'
Electrical Specifications	Power Consumption	< 5W
	Input Power	DC24V, Working range DC 9V~28V
	Power Protection	Protected from thunderstrike and surging
	Power Down Allowed	< 5mS
	CE & RoHS	Complied with EN61000-6-2:2005,EN61000-6-4:2007, ROHS, Surge Immunity:±1KV, EFT:±2KV, ESD:4KV, Air:8KV
Environmental Specifications	Operating Temperature	-20~70C
	Storage Temperature	-30~80C
	Anti-UV	Not suitable to work in strong ultraviolet light (such as direct sunlight)
	Operating Humidity	10~90%RH (no condensate)
	Vibration Endurance	10~25Hz (X,Y,Z direction 2G/30min)
	Cooling	Natural air cooling
Mechanical Index	Degree of Protection	Front IP65 (with NEMA panel, Back IP20)
	Enclosure	The front panel is made of aluminum alloy, the surface is hardened and oxidized, the back shell is galvanized, and the surface is powdered.
	Panel Cutout	120mm×93mm
	Dimension	128mm×102mm×32mm
	Weight	About 500g

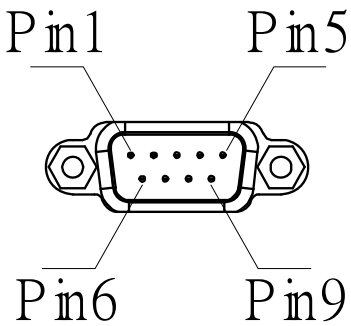
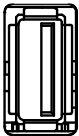
Wiring definition

Power Terminal (Pin1~Pin3 from left to right)		
	Pin1	FG
	Pin2	0V
	Pin3	DC24V
DB9 Serial Terminal (Pin1~Pin9 from left to right)		
	Pin1	Rx-(B)
	Pin2	RxD (COM1 RS232)
	Pin3	TxD (COM1 RS232)
	Pin4	Tx-
	Pin5	GND
	Pin6	Rx+(A)
	Pin7	RxD (COM3 RS232)
	Pin8	TxD (COM3 RS232)
	Pin9	Tx+
USB Host		
	USB Type A	Used to connect U disk, scan code gun and other peripherals
USB Slave		
	Micro USB	Used to download programs and debug
Ethernet Port		
	RJ45	Used to set Ethernet with controller or connect to a server

Size VC4043E

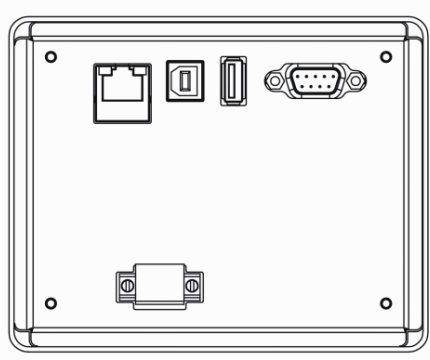
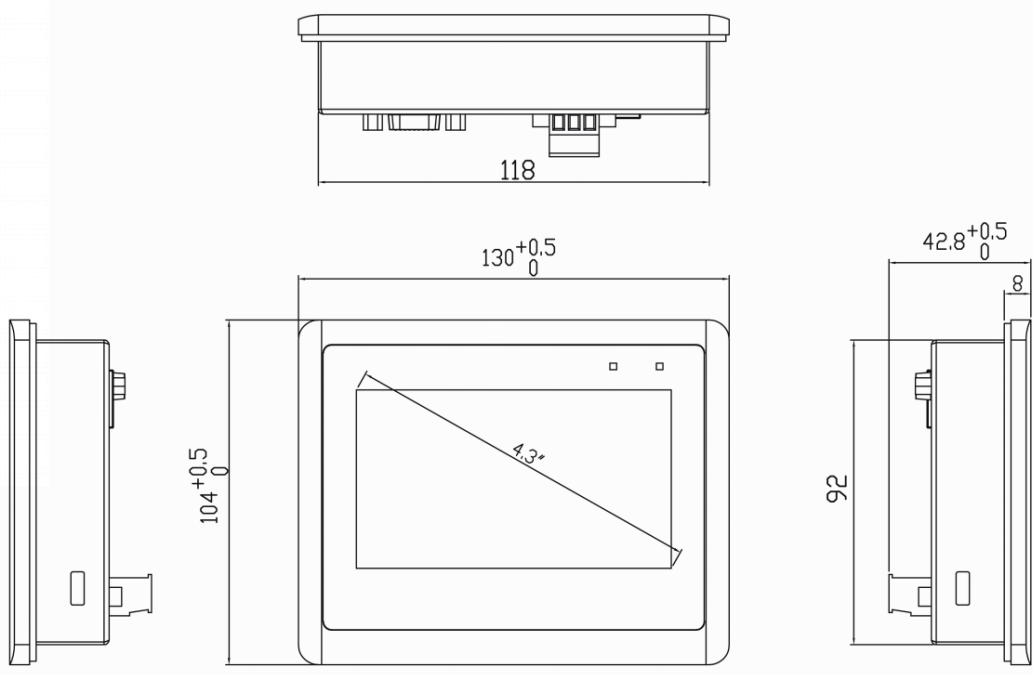

Panel Cutout (W*H):
120.0mm*93.0mm(+1.0mm/-0.0mm)